

IO-Link / analog converter

AI I 0 ... 20mA, M12, straight

Art.No.: 5000-00501-1100000

Weight: 0.045 kg

Country of origin: DE

Model designation: IOL AI-I-V2-0..20mA-UNI

IO-Link / analog converter

AI I 0...20mA, M12

16Bit, IP65/67, IO-Link V1.1, Class A

Link to Product

Illustration

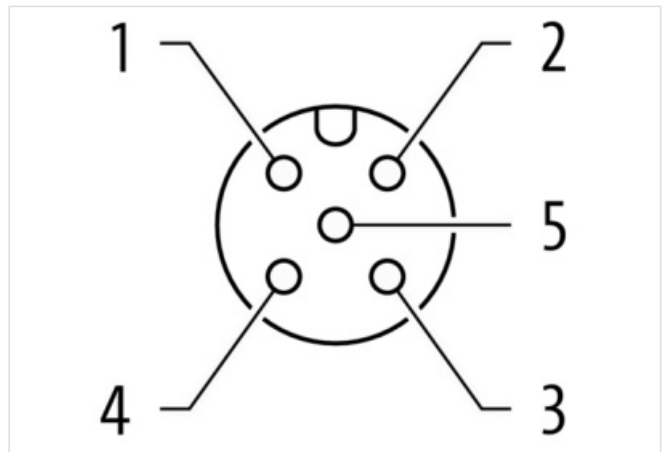
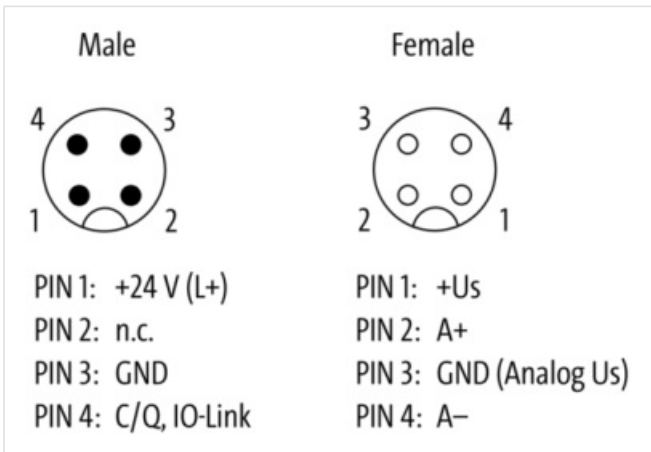
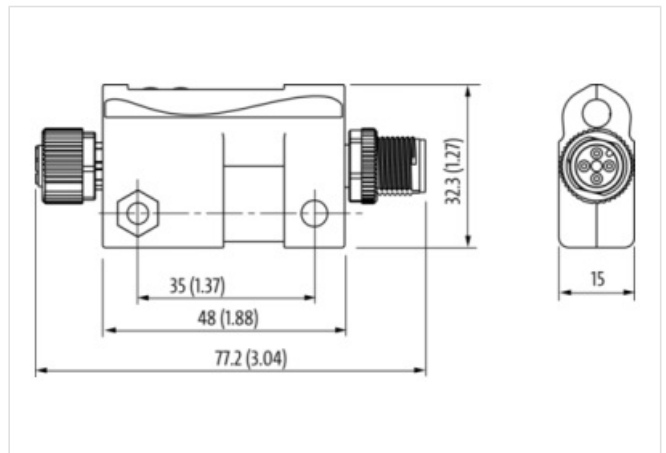



Product may differ from Image

**Commercial data**

URL Webshop	https://shop.murrelektronik.com/5000-00501-1100000
GTIN	4048879622165
Customs tariff number	85437090
ECLASS-6.0	27242601
ECLASS-6.1	27242602
ECLASS-7.0	27242602
ECLASS-7.1	27242602
ECLASS-8.0	27242602
ECLASS-8.1	27242602
ECLASS-9.0	27242602
ECLASS-9.1	27242602
ECLASS-10.0.1	27242602
ECLASS-10.1	27242602
ECLASS-11.0	27242602
ECLASS-11.1	27242602
ECLASS-12.0	27242602
ECLASS-13.0	27242602
ECLASS-14.0	27242602
ETIM-5.0	EC001596
ETIM-6.0	EC001596
ETIM-7.0	EC001596
ETIM-8.0	EC001596
customs tariff number	85437090
EAN	4048879622165
Packaging unit	1

Electrical data | Supply

Norm operating voltage	IEC/EN 61131-2
Operating voltage DC	24 V
Operating voltage DC min.	18 V
Operating voltage DC max.	30 V
Operating voltage US DC	24 V
Current consumption max.	19 mA

Electrical data Input	
Current carrying capacity max.	0,2 A
Parameterizable input averaging filter process data	Yes
Conversion time analog input max.	5 ms
Industrial communication IO-Link	
Port Class	A
revision ID	V1.1
transmission rate	COM2 (38.4 kbit/s)
process data length input	2 bytes
cycle time min.	2,3 ms
Diagnostics	
Short circuit diagnosis	Yes
Overload diagnosis	Yes
Temperature control	Yes
Diagnostic via IO-Link	Yes
Diagnostic via LED	Yes
LED display	Ethernet connection/data traffic
IO-Link events	Undervoltage supply, lower limit, upper limit, Overvoltage supply, Override, Overcurrent sensor supply, Overtemperature, Device defect
Device protection Electrical	
Degree of protection (EN IEC 60529)	IP67, IP65
Invers-polarity protection	Yes
Over voltage protection	Yes
Short circuit protection sensor supply	Yes
Resistance to loads with regenerative power	Yes
Mechanical data Material data	
housing	Plastic
Mechanical data Mounting data	
Height	32,3 mm
Width	77,2 mm
Depth	15 mm
Environmental characteristics Climatic	
Operating temperature min.	-30 °C
Operating temperature max.	70 °C
Ambient temperature (storage, transport)	-40 °C ... 85 °C
Connection type 2	
Connection type 1	AI
Connection type 2	IO-Link AI
Family construction form	M12
No. of poles	4
Coding	A
Gender	female
Color contact carrier	black
PIN 1	+ US
PIN 2	A +
PIN 3	0 V (Analog US)
PIN 4	A -
Family construction form	M12
No. of poles	4
Coding	A
Gender	male

Color contact carrier	black
PIN 1	24 V DC (L +)
PIN 2	n.c.
PIN 3	0 V (L -)
PIN 4	C / Q / IO-Link